

## Connection Module Holder 3U Global/s, 1 GU



## DESCRIPTION

To be mounted into 19" 3U Global patch panels, shielded. Holding capacity: 4 connection modules RJ45/s.



## SCOPE OF SUPPLY

- Connection module holder
- Integrated grounding plate
- Labeling strip
- Installation instructions

## TENDER

Connection module holder Global, shielded, plastic (PC), halogen-free, color light gray (NCS 1005-R80B).

Automatic ground contacting by spring contacts. With a capacity of up to 4 shielded RJ45 connection modules of Category 5, class D, Category 6, class E and Real10 Category 6, class E and class EA for the establishing of transmission channels with up to 4 plugged connections.

## TECHNICAL DATA

| DESCRIPTION             | VALUE / VALUE RANGE |
|-------------------------|---------------------|
| Connector type (A)      | RJ45                |
| Shielding connector (A) | shielded            |
| Protection class IP     | IP 20               |
| Amount of height units  | 3 U                 |
| Rack mounting version   | sub-rack            |
| Assembly                | empty               |
| Capacity (ports)        | 4                   |



















## MECHANICAL DATA





| DESCRIPTION    | VALUE / VALUE RANGE                               |
|----------------|---|
| Color Code NCS | S 1005-R80B                                       |
| Material       | plastic: PC, fiber-glass reinforced, halogen-free |

## ELECTRICAL DATA

| DESCRIPTION | VALUE / VALUE RANGE |
|-------------|---------------------|
| Standard    | UL Listed           |

## ACCESSORIES

| Type          | Picture   | Description                               | Article | E-Number |
|---------------|---|---|---------|----------|
| Accessories   |    | Labeling Sheet Fiberliner / 3U Global Mo  | R30871  |          |
| Panel modules |    | Connection Module Cat. 6, 1xRJ45/s, 10x   | R302372 |          |
| Accessories   |    | Plug Guard Security Level 3 universal IP2 | R304825 |          |
| Accessories   |    | Plug Guard Security Level 3 universal IP2 | R304826 |          |
| Accessories   |    | Plug Guard Security Level 3 universal IP2 | R304827 |          |
| Accessories   |    | Hinged Dust Cover Security Level 1 unive  | R305685 |          |
| Accessories   |    | Hinged Dust Cover Security Level 1 unive  | R305686 |          |
| Accessories   |    | Hinged Dust Cover Security Level 1 unive  | R305687 |          |
| Accessories   |  | Hinged Dust Cover Security Level 1 unive  | R305688 |          |
| Accessories   |  | Hinged Dust Cover Security Level 1 unive  | R305689 |          |
| Accessories   |  | Hinged Dust Cover Security Level 1 unive  | R305690 |          |
| Accessories   |  | Hinged Dust Cover Security Level 1 unive  | R305691 |          |
| Accessories   |  | Hinged Dust Cover Security Level 1 unive  | R305692 |          |
| Accessories   |  | Hinged Dust Cover Security Level 1 unive  | R305693 |          |
| Accessories   |  | Splash Cap Security Level 1 universal IP  | R306058 |          |
| Accessories   |  | Splash Cap Security Level 1 universal IP  | R306060 |          |
| Accessories   |  | Splash Cap Security Level 1 universal IP  | R306061 |          |
| Accessories   |  | Splash Cap Security Level 1 universal IP  | R306062 |          |

| Type          | Picture   | Description                              | Article | E-Number |
|---------------|---|--|---------|----------|
| Accessories   |   | Splash Cap Security Level 1 universal IP | R306063 |          |
| Accessories   |  | Plug Reduction Frame RJ45 onto RJ11/R    | R310835 |          |
| Panel modules |  | Connection Module Cat. 6A, 1xRJ45/s, 1   | R509504 |          |
| Panel modules |  | Connection Module Cat. 6A EL, 1xRJ45/s   | R813504 |          |
| Panel modules |  | Connection Module Cat. 5e, 1xRJ45/s, 10  | R925370 |          |

Wir behalten uns alle Rechte an diesem Dokument vor.  
 Der Empfänger anerkennt dies und wird dieses Dokument  
 nicht ohne unsere schriftliche Ermächtigung ganz oder  
 teilweise Dritten zugänglich machen oder ausserhalb des  
 Zweckes verwenden, zu dem es ihm uebergeben worden ist.

c

b

a

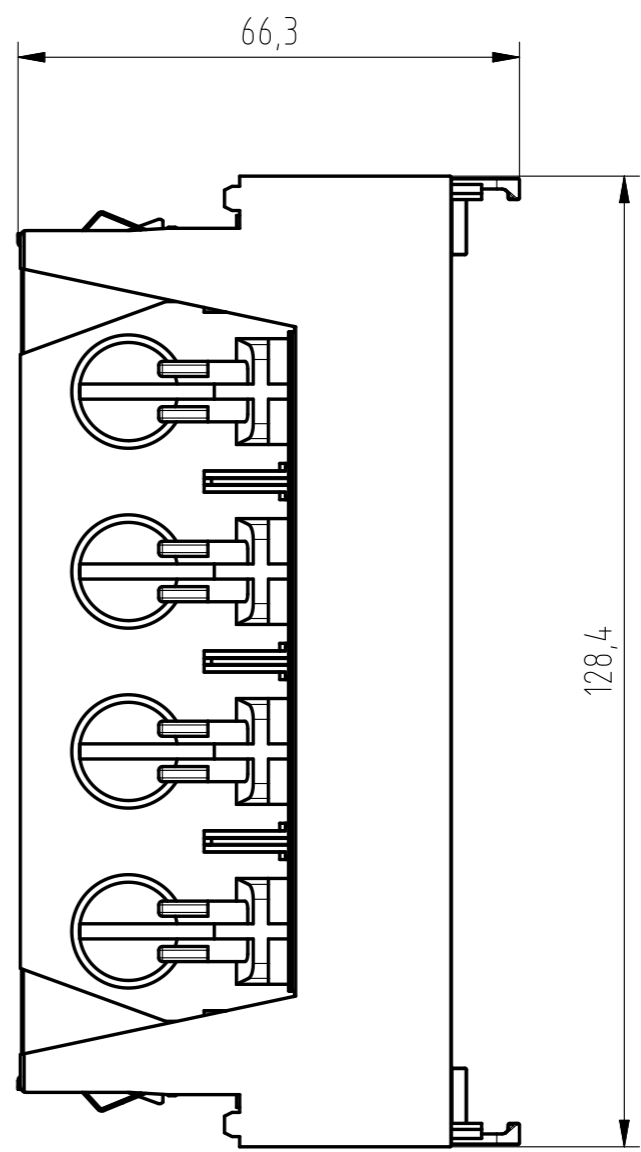
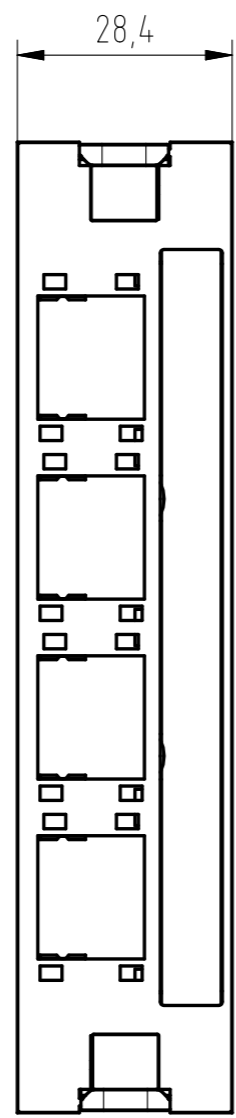
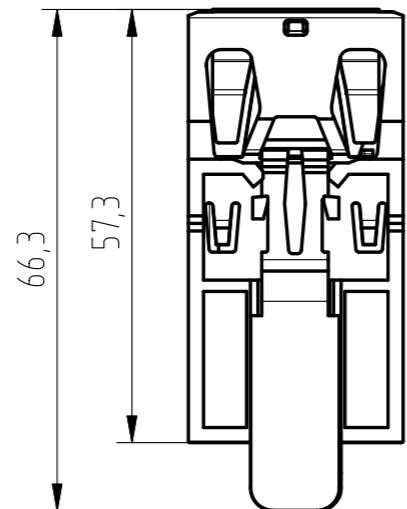

|   |  |                      |             |            |              |
|---|--|----------------------|-------------|------------|--------------|
| <b>Material</b>   |  | <b>Toleranz nach</b> |             |            |              |
| <b>Behandl</b>  |  |                      |             |            |              |
| <b>Farbe</b>  |  |                      |             |            |              |
| <b>Benennung</b>  | Anschlussmodulträger<br>Global geschirmt | <b>Mst</b>           | <b>Gez</b>  | 27.02.2008 | Cp           |
|   |  | 1:1                  | <b>Frg</b>  | 04.03.2008 | Ma           |
|  Reichle & De-Massari AG<br>Binzstrasse 31<br>CH-8622 Weizikon<br>Telefon +41 (0)44 933 81 11<br>Telefax +41 (0)44 930 49 41 |  | <b>Volumen</b>       | <b>Form</b> | A3         | BI           |
|   |  | <b>Art Nr</b>        | 35402_-7    |            | <b>Index</b> |