

FEATURES	
Technology	PIM (Per Inlet Monitoring)
Energy Metering	Voltage(V), Current(A), Active Power(W), Apparent Power (VA), Reactive Power (var), PF, Frequency(Hz), kWh
Metering per Input Line	Yes (Branch Circuit and Total Current) Accuracy 1%
Metering per Output Receptacle	No
Remote Outlet Switching	No
Ethernet Port	2 Gigabit Ethernet ports to access the PDU from 2 different networks
Networking Protocols	DHCP, IPv4 and IPv6, DNS, http / https, SSHv.2, SNMP v1 / v2c / v3, SNMP TRAPS / SETS / GETS, SMTP, Modbus , Telnet, TCP, RADIUS, Syslog, TLS 1.2, SNTP, ARP, ICMP, ICMPv6, UDP, NDP
PDU Cascading	16 PDUs
Power Share	Yes
Network Controller	Replaceable Hot Swapable controller with 4 button OLED display
Residual Current Monitoring	No (optional)
Rack Acces Control	Compatible with DCIM solutions
USB Ports	2 USB A ports WiFi networking,webcam,PDU configuration and mobile interface
Environmental Sensors	All in one Temperature and Humidity sensor with 2 digital inputs (for connect air flow, door sensor, water leak, smoke detector and Vibration sensor) plug and play bus allows to connect 8 EMD devices in one PDU
INPUT	
Plug	IEC60309 3P+N+E 6h 32A 380-415V
Lead Length	3 meter
Cable Type	H07RN-F5G4.0 mm ²
Max. Input Load	32A
Rated Input Voltage	380-415V three phase
Frequency	50-60Hz
Power Capacity	22.1kW
OUTPUT	
Rated Output Voltage	190-250V Single phase
Output Types	42 IEX (C13/C19) combo (Max rate 16A) EN61984+UL498 certified
Overload Protection	(6) 1 Pole Carling 16A L31-X1-00-445-H62-D3
CHASSIS	
Dimensions (W x D x H)	2100 x 60 x 72 mm
Color	RAL 9004 black powder coat
Mounting Options	4 mounting options (see page 2)
Required Torque for Mounting Screws	≥2.54N·m (25.9kgf·cm or 22.4 in·lbs)
OPERATING ENVIRONMENT	
Temperature Range	0° to 60° C (30° to 140° F)
Humidity	0 - 95 %
Elevation	0 - 4000 Meters
CONFORMANCE	
IEC 62368-1 (Third Edition)	

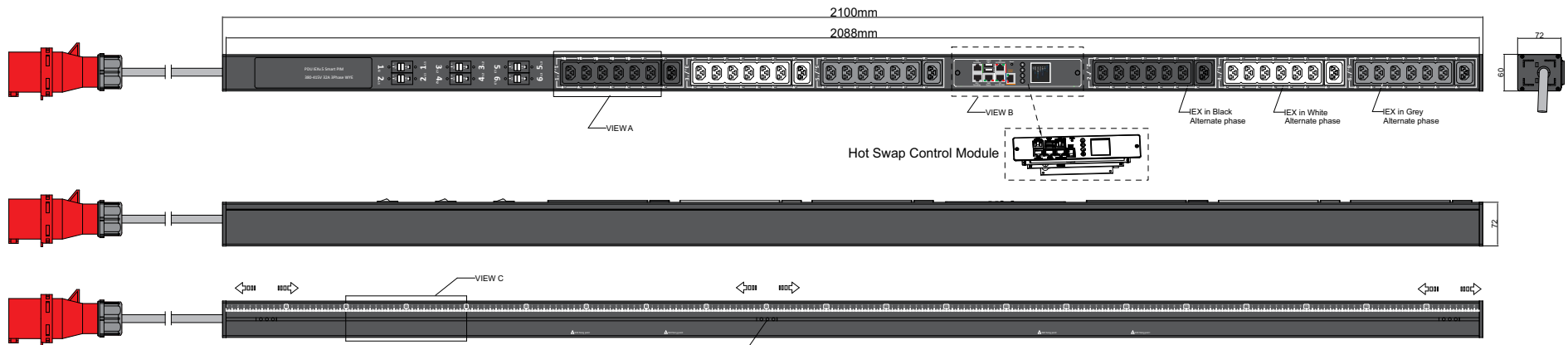

VIEW B:

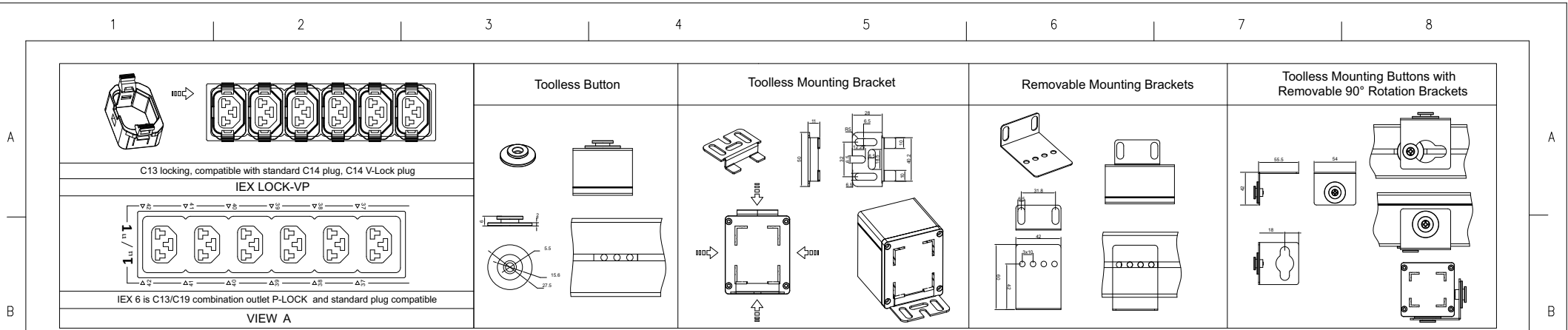
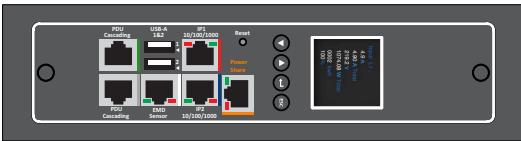

VIEW C:

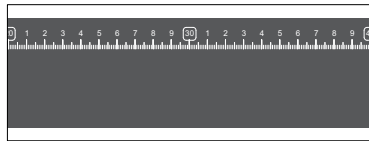



Chassis Color	Code
Black	Standard color
White	W
Red	R
Blue	A
Green	G
Orange	O
Grey	GY
Yellow	Y

Packing content:

IEX Lock-VP  X42 Red

PIM Series Inlet Power Monitoring Environmental Monitoring	OUTPUT (14) IEX (C13/C19) combo Black (Max rate 16A) (14) IEX (C13/C19) combo White (Max rate 16A) (14) IEX (C13/C19) combo Grey (Max rate 16A)	OPERATING TEMPERATURE 0° to 60°C
	INPUT 380-415VAC 16A 50HZ IEC60309 16A 3P+N+E Plug 3m H07RN-F5G2.5mm ² Power Lead	BRANCH CIRCUITS

DRAWING TYPE  (NO PERMISSION, NO CHANGING)		IEXPIM504216A3PV							
unit=mm TECHNICAL STANDARD IT11; NO RUST NO FLAW ON THE SURFACE		Housing Aluminium Black Powder Coating RAL9004							
FILLET R0.5	ANGLE ±0.5°			DATE 28-06-2021					
FIRST ANGLE 									
Revisions	<table border="1"> <thead> <tr> <th>Rev</th> <th>Description</th> <th>Date</th> </tr> </thead> <tbody> <tr> <td> </td> <td> </td> <td> </td> </tr> </tbody> </table>	Rev	Description	Date					
Rev	Description	Date							

- Low cost locking solution at both ends
- Different colors available
- Patented IEX locking system
- Locking sleeve for C13 and C19 plugs
- VDE, UL approved

IEX PATENTED LOCKING SOCKET - POWER CORD SOLUTION



C14 - C13 Sleeve

H05VV-F3G1 mm²

Color	0,5M	1M	2M
Black	✓	✓	✓
Red	✓	✓	✓
Blue	✓	✓	✓

C14PLOCK - C13 Sleeve

H05VV-F3G1 mm²

Color	0,5M	1M	2M
Black	✓	✓	✓
Red	✓	✓	✓
Blue	✓	✓	✓

C20PLOCK - C19 Sleeve

H05VV-F3G1,5 mm²



Color	1M	2M
Black	✓	✓
Red	✓	✓
Blue	✓	✓

C20PLOCK - C13 Sleeve

H05VV-F3G1 mm²

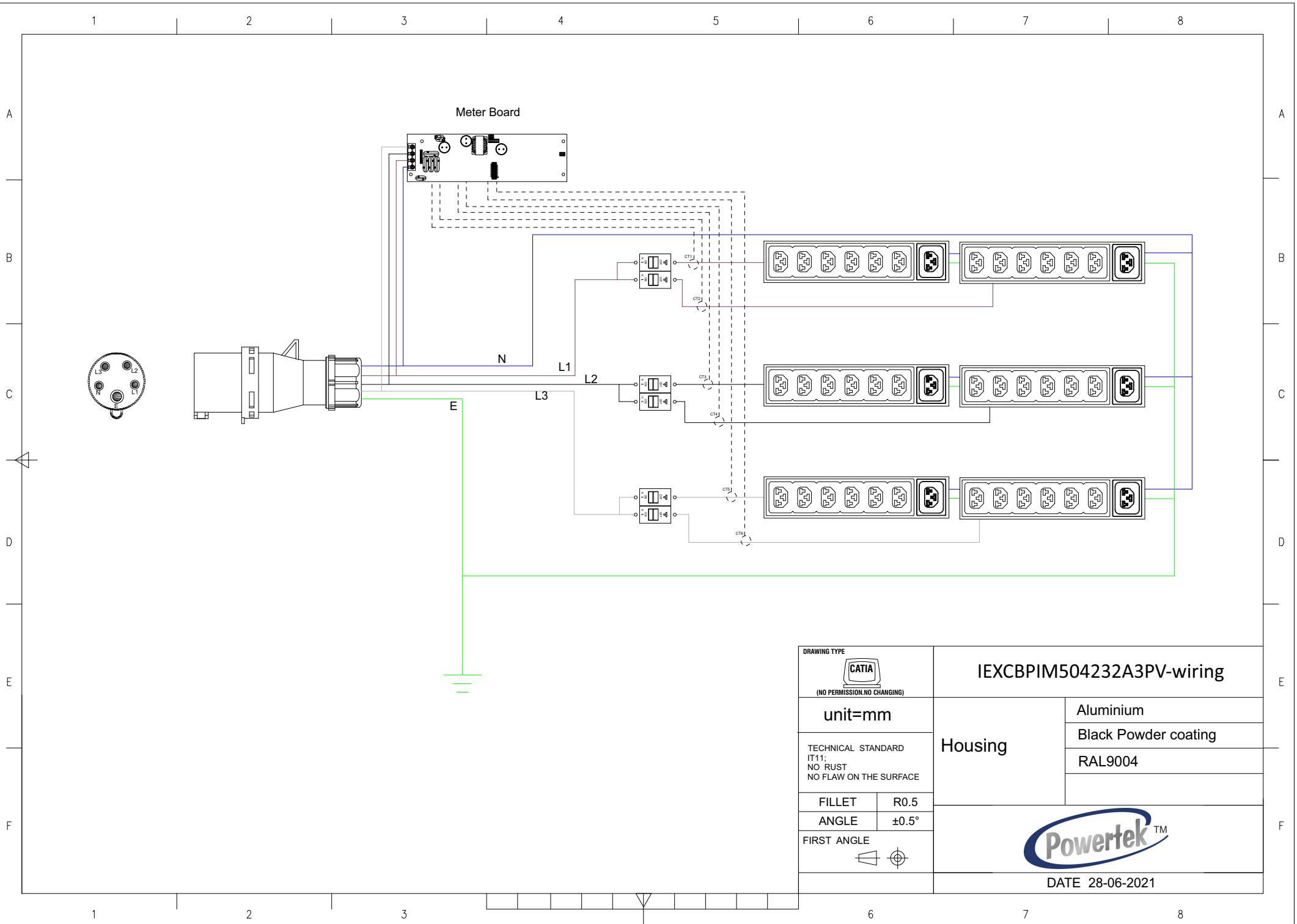
Color	1M	2M
Black	✓	✓
Red	✓	✓
Blue	✓	✓



DRAWING TYPE	
 (NO PERMISSION, NO CHANGING)	
unit=mm	
TECHNICAL STANDARD IT11; NO RUST NO FLAW ON THE SURFACE	
FILLET	R0.5
ANGLE	±0.5°
FIRST ANGLE	
	

IEXCBPIM504232A3PV-wiring	
Housing	Aluminium
	Black Powder coating
	RAL9004
	
DATE 28-06-2021	