

FEATURES	
Technology	PIM (Per Inlet Monitoring)
Energy Metering	Voltage(V), Current(A), Active Power(W), Apparent Power (VA), Reactive Power (var), PF, Frequency(Hz), kWh
Metering per Input Line	Yes (Branch Circuit and Total Current) Accuracy 1%
Metering per Output Receptacle	No
Remote Outlet Switching	No
Ethernet Port	2 Gigabit Ethernet ports to access the PDU from 2 different networks
Networking Protocols	DHCP, IPv4 and IPv6, DNS, http / https, SSHv.2, SNMP v1 / v2c / v3, SNMP TRAPS / SETS / GETS, SMTP, Modbus , Telnet, TCP, RADIUS, Syslog, TLS 1.2, SNTP, ARP, ICMP, ICMPv6, UDP, NDP
PDU Cascading	16 PDUs
Power Share	Yes
Network Controller	Replaceable Hot Swapable controller with 4 button OLED display
Residual Current Monitoring	No (optional)
Rack Acces Control	Compatible with DCIM solutions
USB Ports	2 USB A ports WiFi networking,webcam,PDU configuration and mobile interface
Environmental Sensors	All in one Temperature and Humidity sensor with 2 digital inputs (for connect air flow, door sensor, water leak, smoke detector and Vibration sensor) plug and play bus allows to connect 8 EMD devices in one PDU
INPUT	
Plug	IEC60309 3P+N+E 6h 16A 380-415V
Lead Length	3 meter
Cable Type	H07RN-F5G2.5 mm <sup>2</sup>
Max. Input Load	16A
Rated Input Voltage	380-415V three phase
Frequency	50-60Hz
Power Capacity	11kW
OUTPUT	
Rated Output Voltage	190-250V Single phase
Output Types	42 IEX (C13/C19) combo (Max rate 16A) EN61984+UL498 certified
Overload Protection	None
CHASSIS	
Dimensions (W x D x H)	1800 x 60 x 72 mm
Color	RAL 9004 black powder coat
Mounting Options	4 mounting options (see page 2)
Required Torque for Mounting Screws	≥2.54N·m (25.9kgf·cm or 22.4 in·lbs)
OPERATING ENVIRONMENT	
Temperature Range	0° to 60° C (30° to 140° F)
Humidity	0 - 95 %
Elevation	0 - 4000 Meters
CONFORMANCE	
IEC 62368-1 (Third Edition)	

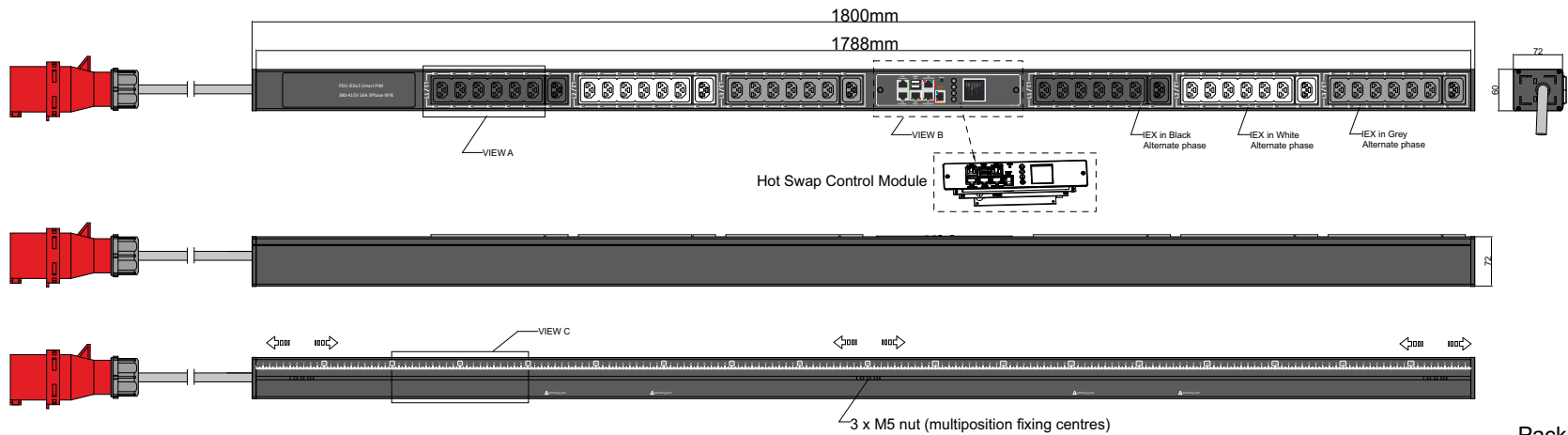

VIEW B:

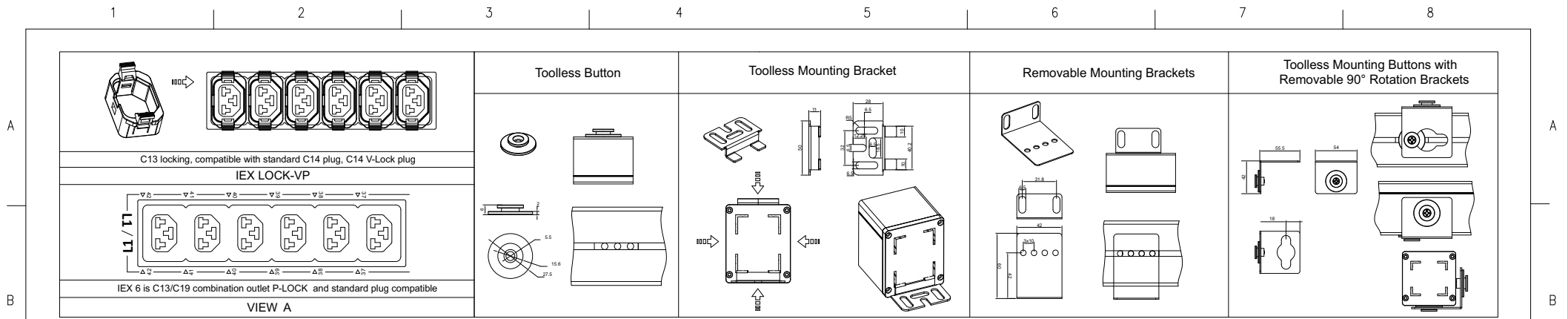
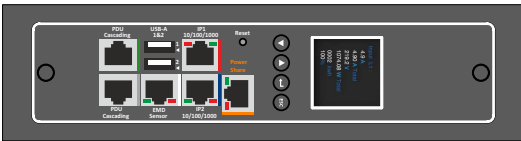

VIEW C:

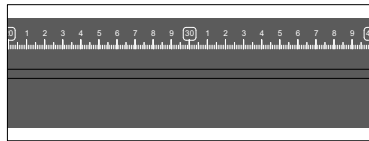



Chassis Color	Code
Black	Standard color
White	W
Red	R
Blue	A
Green	G
Orange	O
Grey	GY
Yellow	Y

Packing content:  
IEX Lock-VP  X42 Red

<b>PIM Series</b> Inlet Power Monitoring Environmental Monitoring	<b>OUTPUT</b> (14) IEX (C13/C19) combo Black (Max rate 16A) (14) IEX (C13/C19) combo White (Max rate 16A) (14) IEX (C13/C19) combo Grey (Max rate 16A)	<b>OPERATING TEMPERATURE</b> 0° to 60°C
	<b>INPUT</b> 380-415VAC 16A 50HZ IEC60309 16A 3P+N+E Plug 3m H07RN-F5G2.5mm <sup>2</sup> Power Lead	<b>BRANCH CIRCUITS</b>

Revisions		
Rev	Description	Date

DRAWING TYPE  (NO PERMISSION, NO CHANGING)	<b>IEXPIM504216A3PV</b>	
unit=mm TECHNICAL STANDARD IT11; NO RUST NO FLAW ON THE SURFACE	<b>Housing</b>	Aluminium Black Powder Coating RAL9004
FILLET R0.5 ANGLE ±0.5° FIRST ANGLE 		 DATE 28-06-2021

- Low cost locking solution at both ends
- Different colors available
- Patented IEX locking system
- Locking sleeve for C13 and C19 plugs
- VDE, UL approved

# IEX PATENTED LOCKING SOCKET - POWER CORD SOLUTION



## C14 - C13 Sleeve

H05VV-F3G1 mm<sup>2</sup>

Color	0,5M	1M	2M
Black	✓	✓	✓
Red	✓	✓	✓
Blue	✓	✓	✓

## C14PLOCK - C13 Sleeve

H05VV-F3G1 mm<sup>2</sup>

Color	0,5M	1M	2M
Black	✓	✓	✓
Red	✓	✓	✓
Blue	✓	✓	✓

## C20PLOCK - C19 Sleeve

H05VV-F3G1,5 mm<sup>2</sup>



Color	1M	2M
Black	✓	✓
Red	✓	✓
Blue	✓	✓

## C20PLOCK - C13 Sleeve

H05VV-F3G1 mm<sup>2</sup>

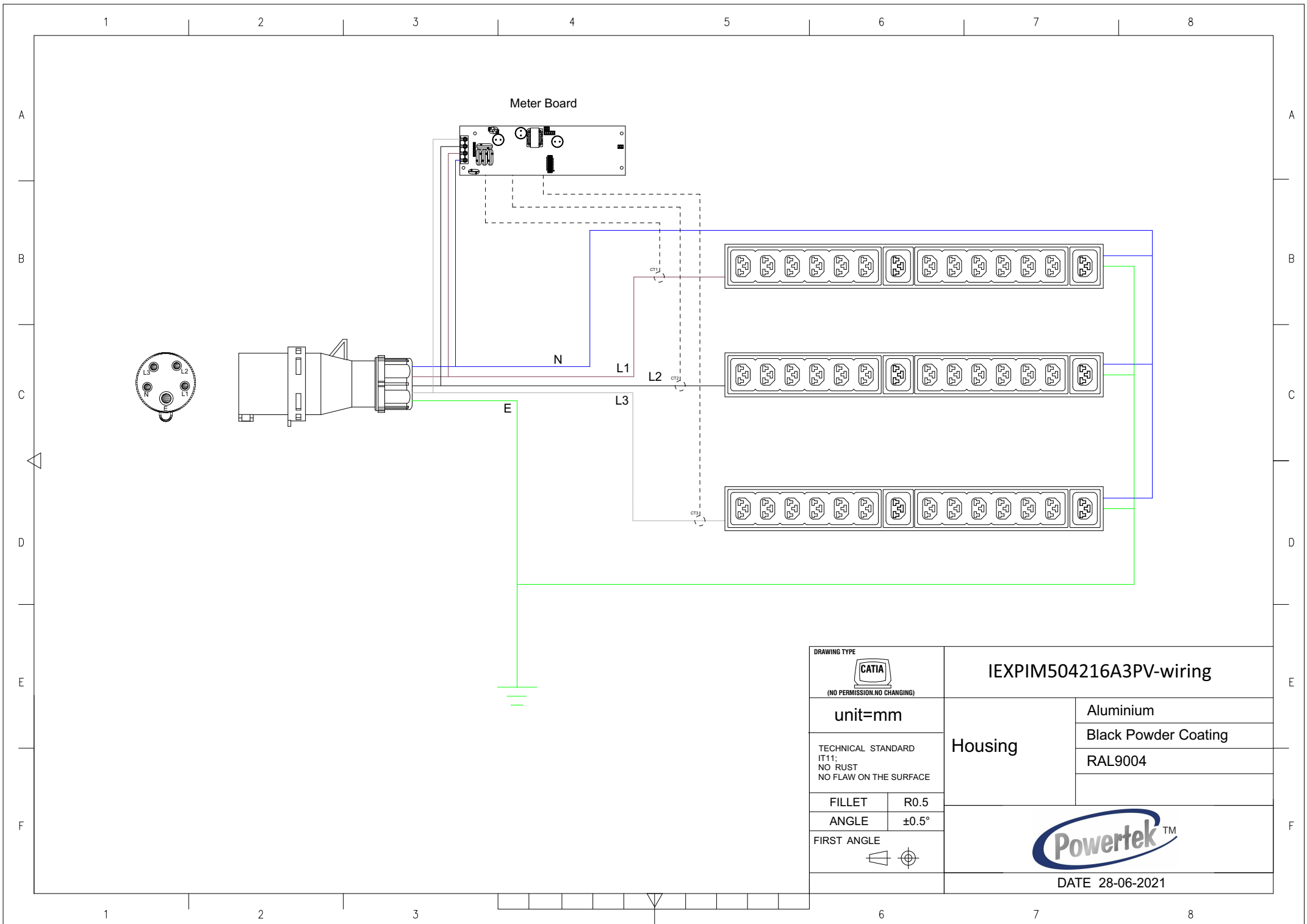
Color	1M	2M
Black	✓	✓
Red	✓	✓
Blue	✓	✓



DRAWING TYPE		IEXPIM504216A3PV-wiring	
 (NO PERMISSION, NO CHANGING)		Housing	Aluminium
unit=mm			Black Powder Coating
TECHNICAL STANDARD IT11; NO RUST NO FLAW ON THE SURFACE			RAL9004
FILLET	R0.5		
ANGLE	±0.5°		
FIRST ANGLE			
		DATE 28-06-2021	