

## U-Series 2RU Housing

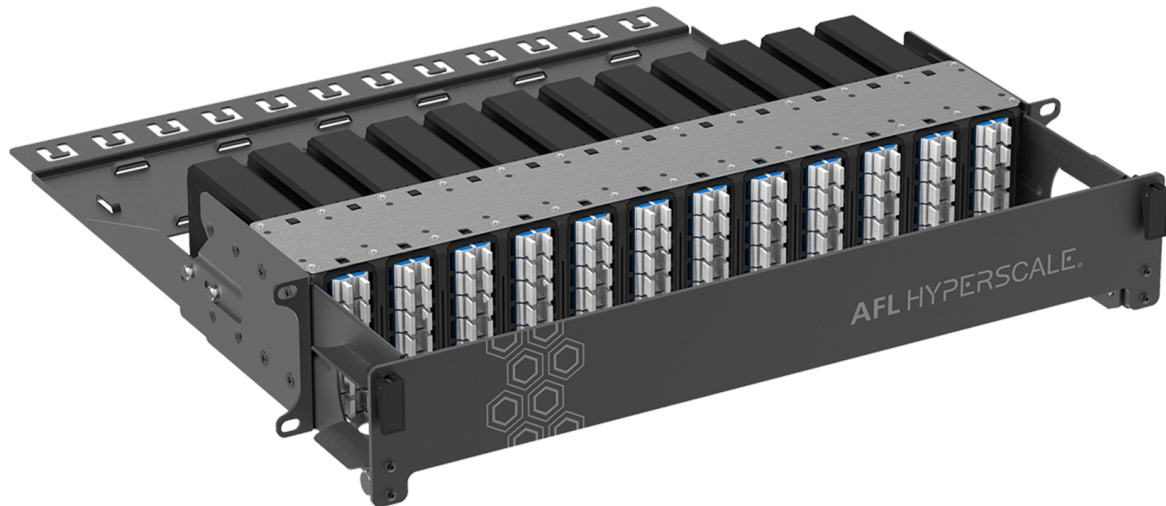

### Description

The U-Series 2RU Housing can house up to 12 U-Series cassettes with the capacity to scale up to 288 LC ports and 2304 fibers using an MPO interface. Compact to facilitate installation in shallow-depth racks, it allows for front and rear cassette installation and is compatible with U-Series MPO, pre-terminated, and splice cassettes.

### Features and Benefits

- Up to 288 LC ports in 2RU
- Compact size for installation shallow-depth racks
- Front and rear cassette access
- Cable management accessories
- Up to 3456 fibers using an MPO interface
- Secure, easy-access lock-and-release mechanism
- Facilitated patch cord installation

### Applications

- Data center
- Enterprise / Campus
- Central Office / POP
- LAN

### Specifications

Element	Characteristic
Height	88mm
Width	484mm

Element	Characteristic
Depth (full configuration with door)	139mm
Weight (without packaging)	1.97 kg
Weight (with packaging)	2.31 kg
Maximum fiber count	144f (LC/SC), 288f (LC), 3456f (MPO)
Maximum number of U-Series adapter plates	12
Cable entry	Left and right
Operating temperature	-20°C to +50°C
Designed in accordance with	TIA/EIA 568.C, ISO/IEC 11801, EN 50173, IEC 60304, IEC 61754,
Materials compliant to	RoHS, Reach / SVHC

## External Housing - Side Wall

Material	ABS
Color	Black

## External Housing Top and Bottom Plate

Material	Aluminum
Color	Black

## 2RU Side Brackets, Door Mount Plate

Material	CR4 Steel
Color	Black

## 2RU Front Door

Material	Aluminum
Color	Black

## Technical Drawing

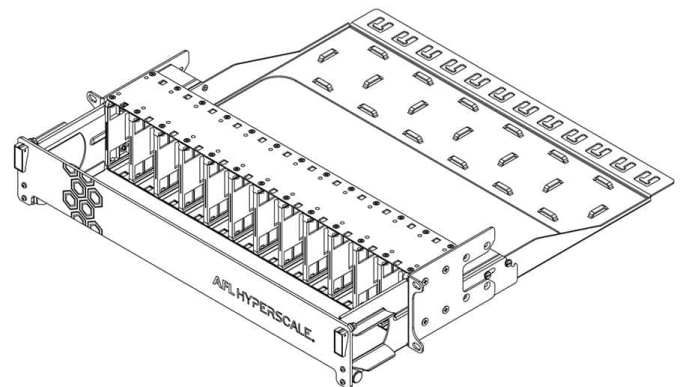
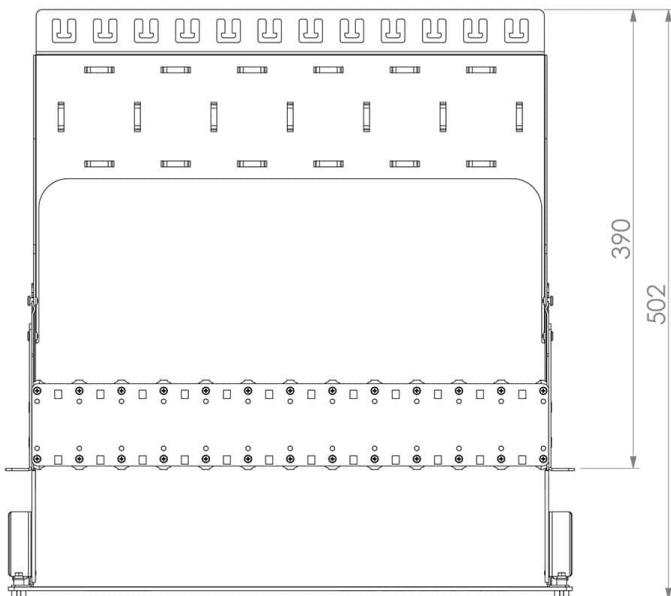
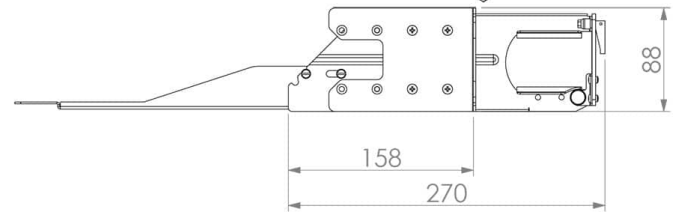
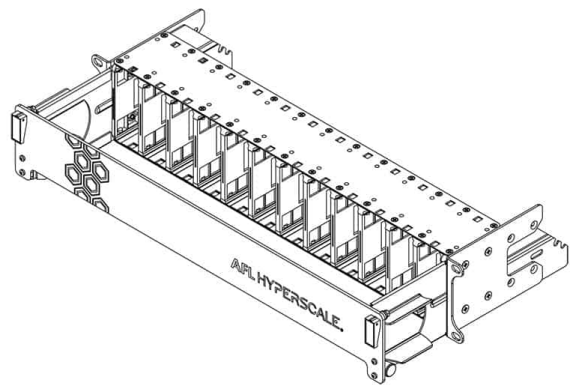
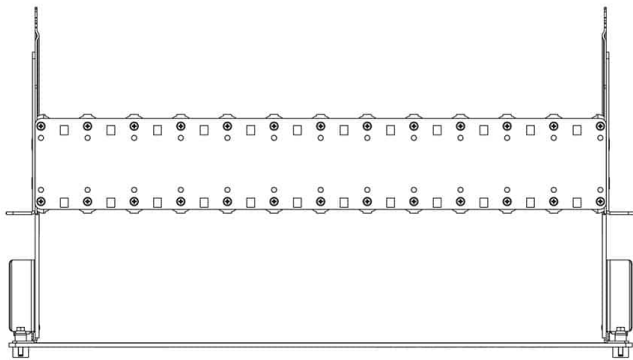
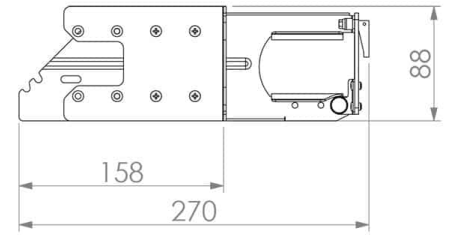
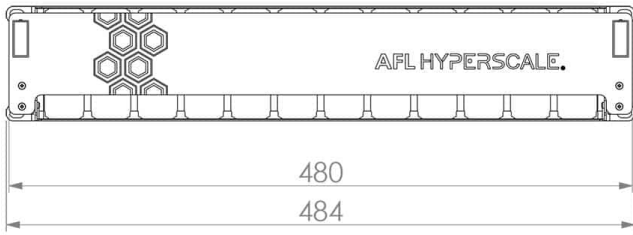

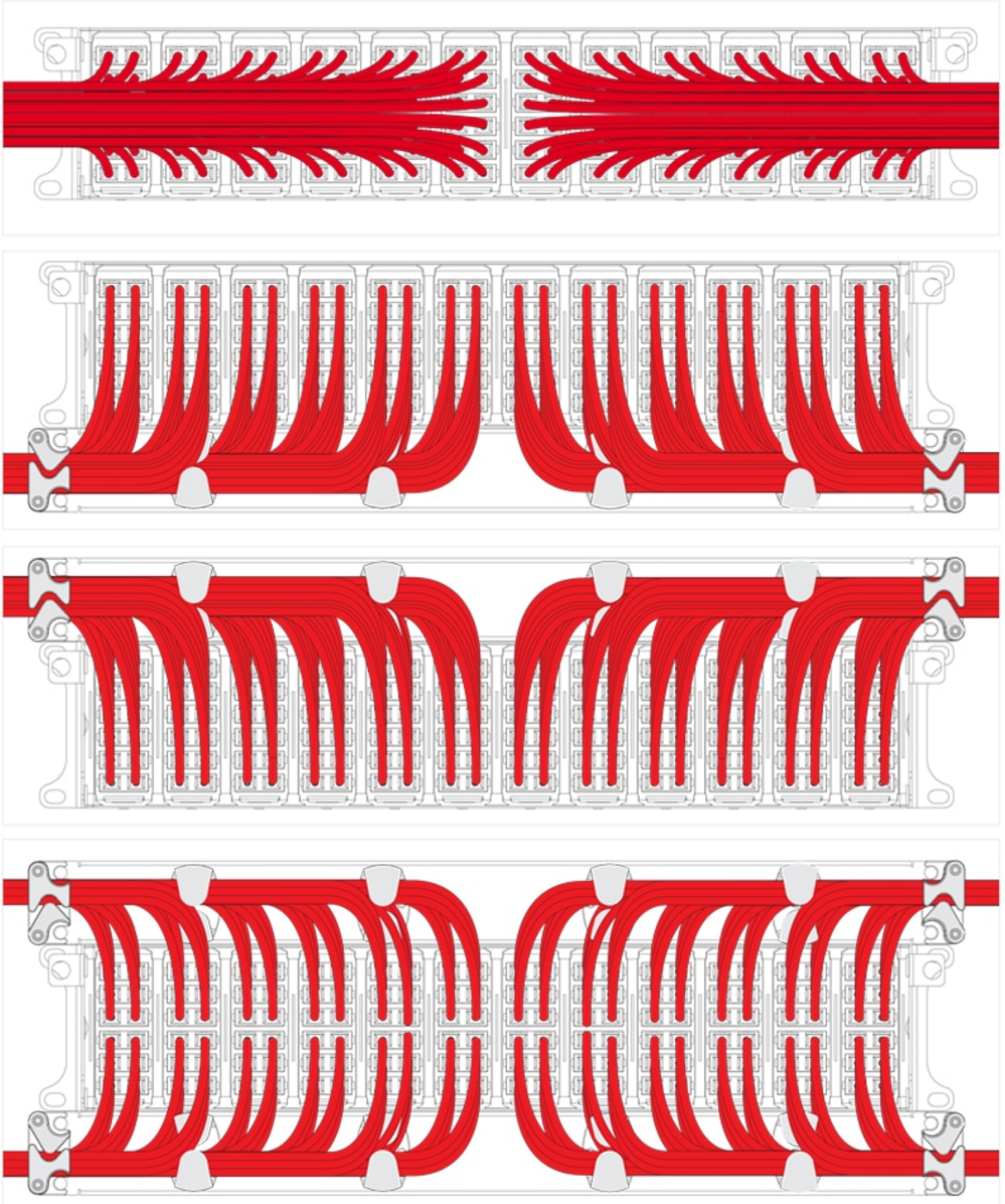



## Ordering Information

Part Number	Description
FXUCXXBXXX-02BH	U-Series 2RU Housing 12 Cassettes Black (Front Door+Rear Mgt)

## Regional Availability

USA	EMEA	INDIA	APAC (excluding India)
+1-866-814-8615 usasales@aflyperscale.com	+44 1908 441 144 emeasales@aflyperscale.com	+91 80 46874687 indiasales@aflyperscale.com	+86 755 2561 3694 apacsales@aflyperscale.com

## Additional Images

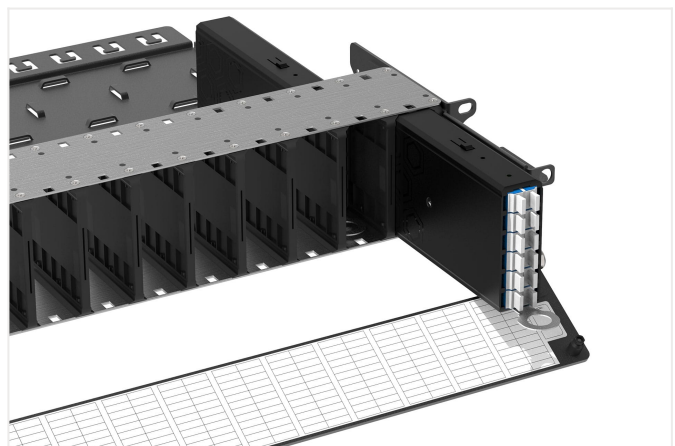
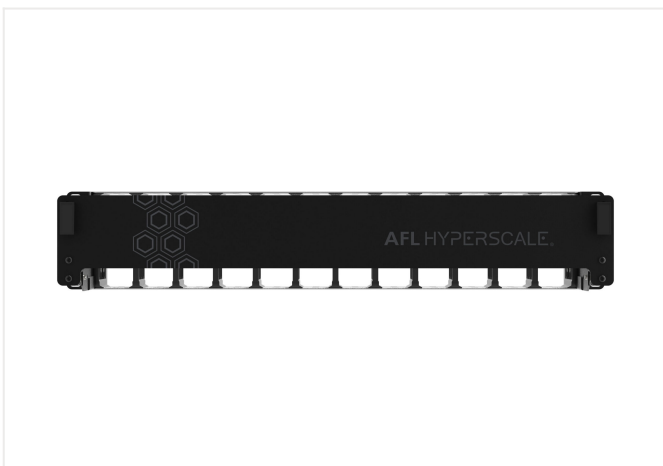
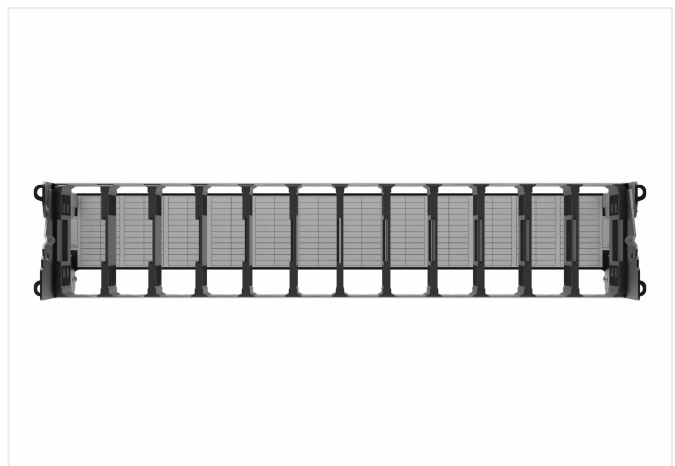
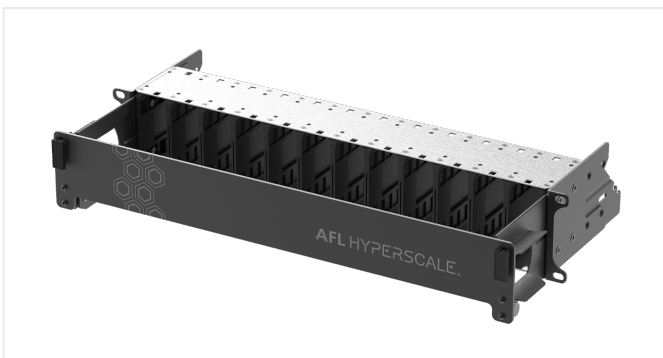

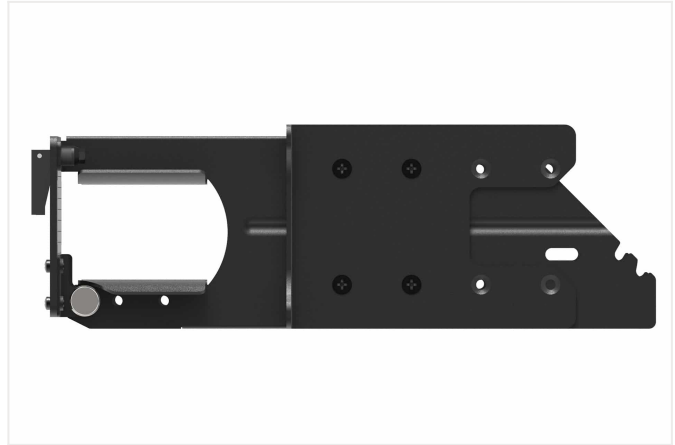
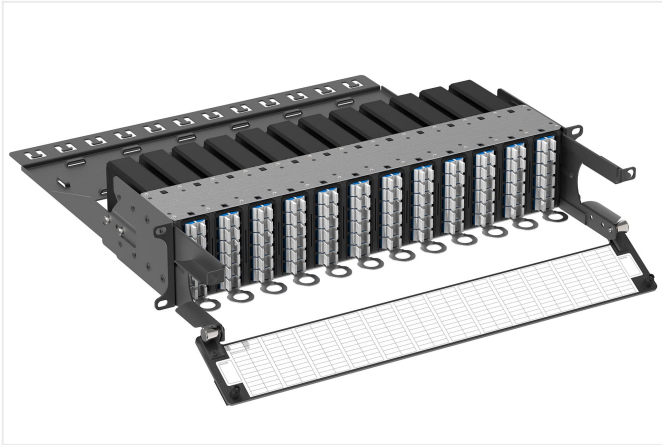

## Related Products

